

CATÁLOGO

FERRE BULLDOG
— MARCAMOS LA DIFERENCIA —

FERRE BULLDOG
— MARCAMOS LA DIFERENCIA —

www.ferrebulldog.com

Tel: 317 439 2379

contacto@ferrebulldog.com

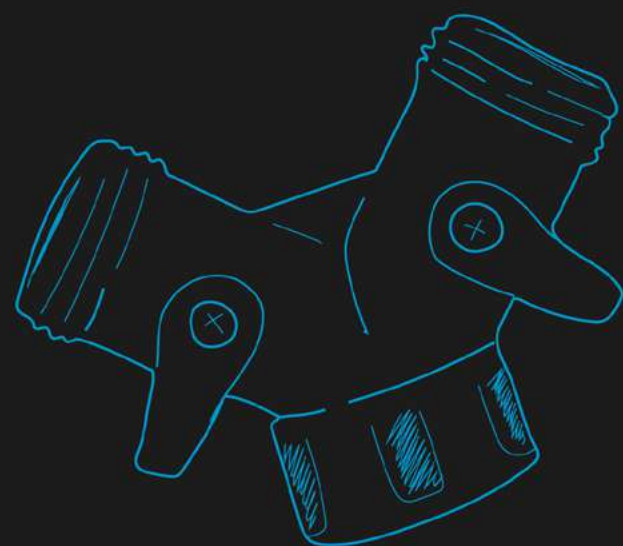
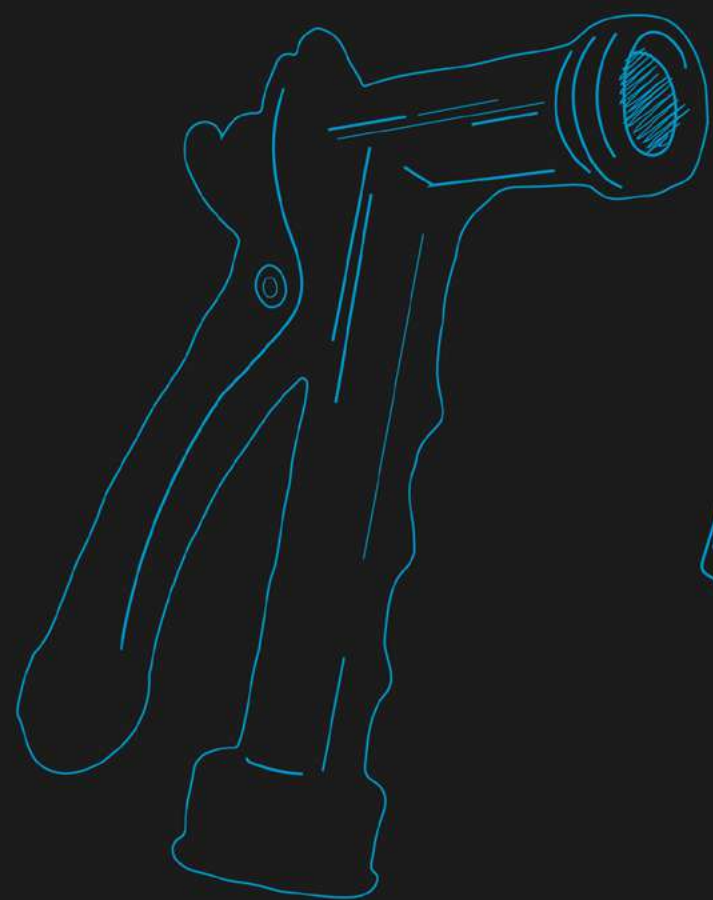
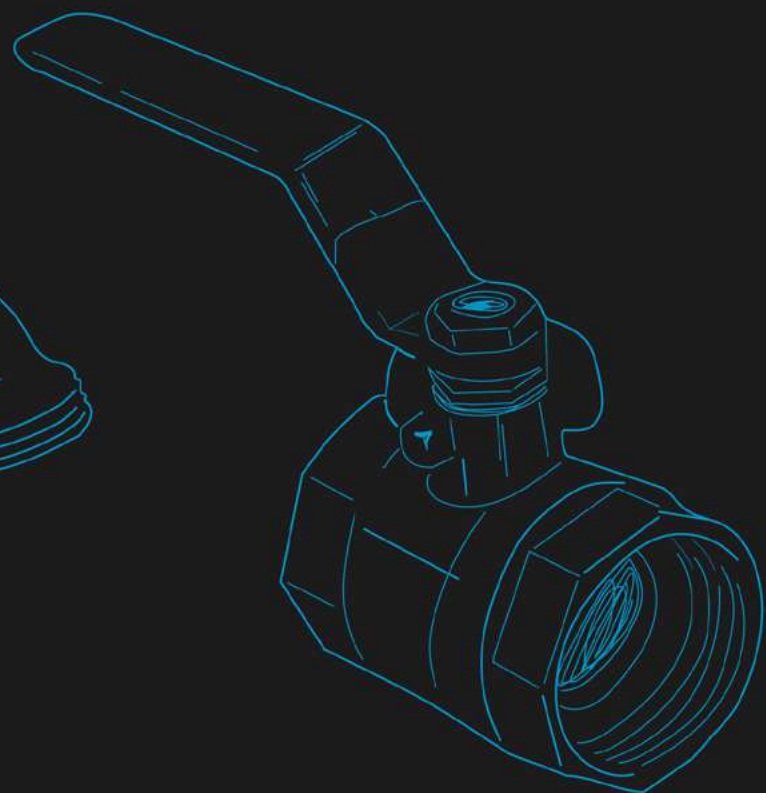

Línea de
AGUA

MANGUERA x100m

2" REF. 220802-31

3" REF. 220802-32

4" REF. 220802-33



REGISTRO DE PASO en bronce

1 1/4" REF. UD3018

• Utilizado como medio para expulsar agua.



REGISTRO PVC

1/2" ROSCA REF. 1001-71

1/2" LISO REF. 1001-72

3/4" LISO REF. ZDC151

• Utilizado como unión entre dos puntos.

ROCEADOR

gris metálico

REF. SY-31010 / IP11156



• Utilizado como medio para expulsar agua.



ROCEADOR

agua

REF. 1001-144



• Utilizado como medio para expulsar agua.

ROCEADOR

Pistola de agua

REF. 1001-39



• Utilizado como medio para expulsar agua.



ROCEADOR

agua 5 chorros

REF. 1001-1456



• Utilizado como medio para expulsar agua.

ASPERSOR

estaca

REF. 1001-148

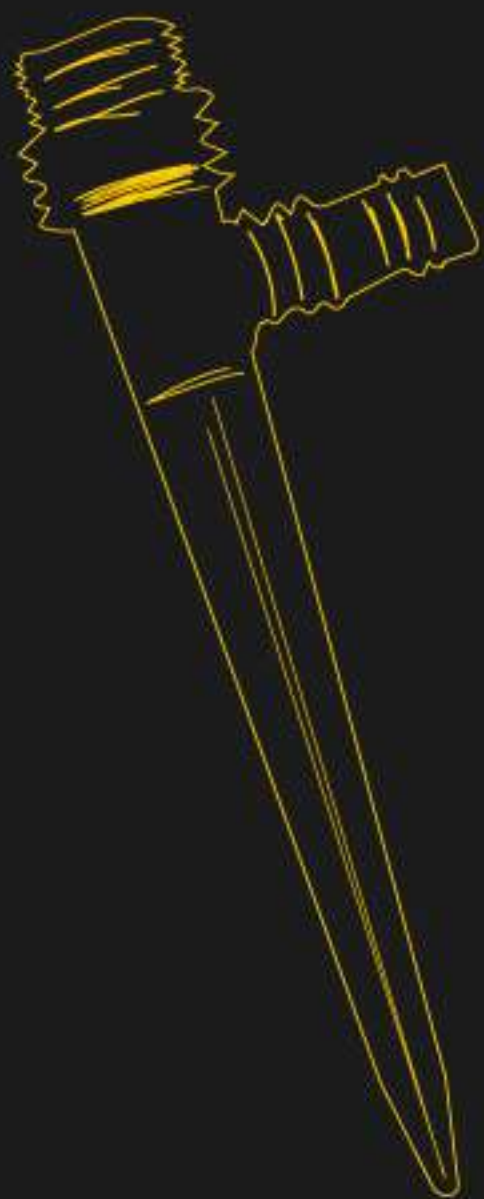

LLAVE

terminal PVC

REF. 1001-70



SASCO con adaptador

Ref: ZDA136B / ZDA1704

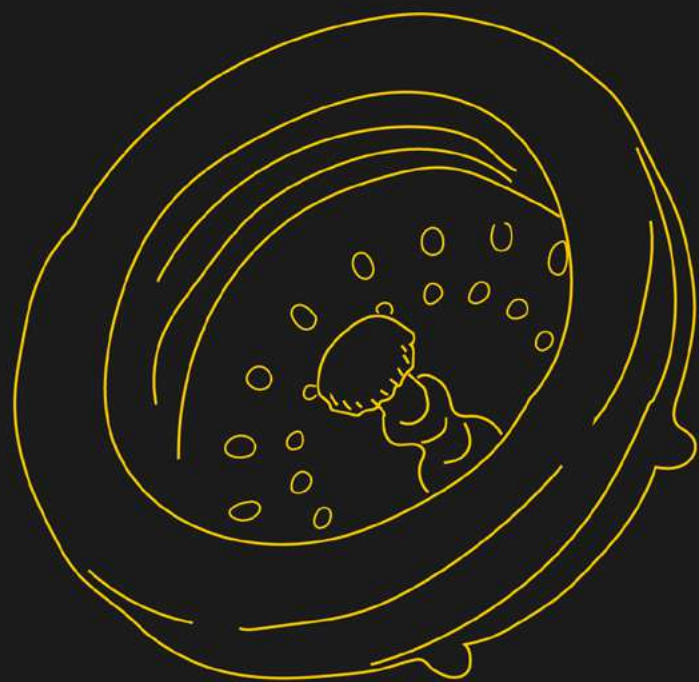

VARILLA de 25mm

REF. IP11334

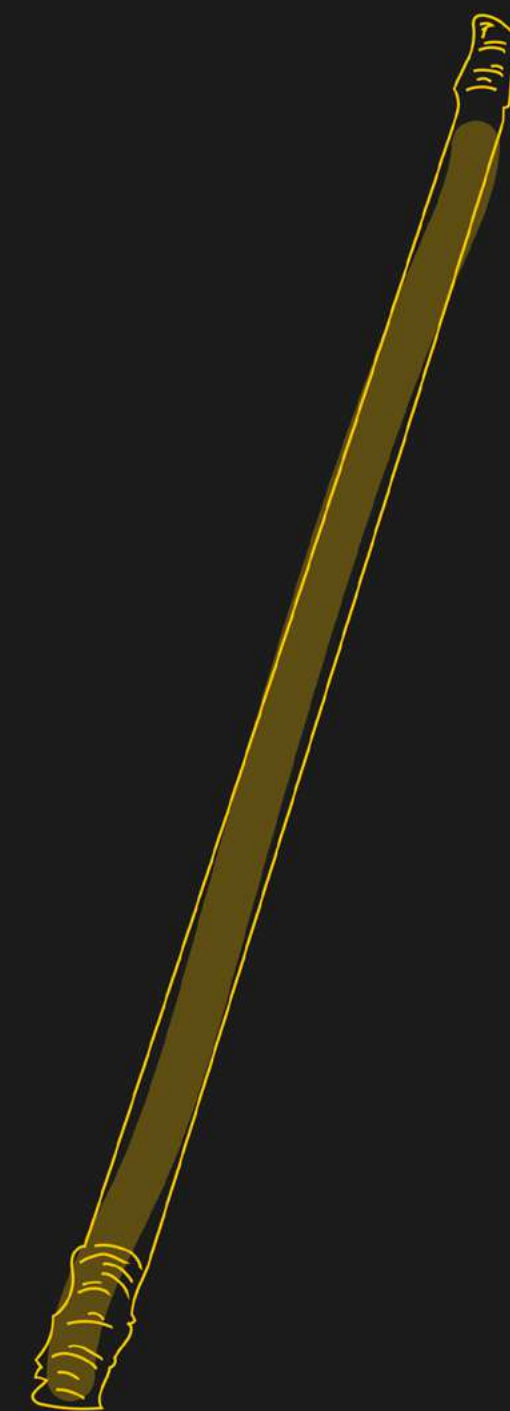

• Para flotador tanque WC.

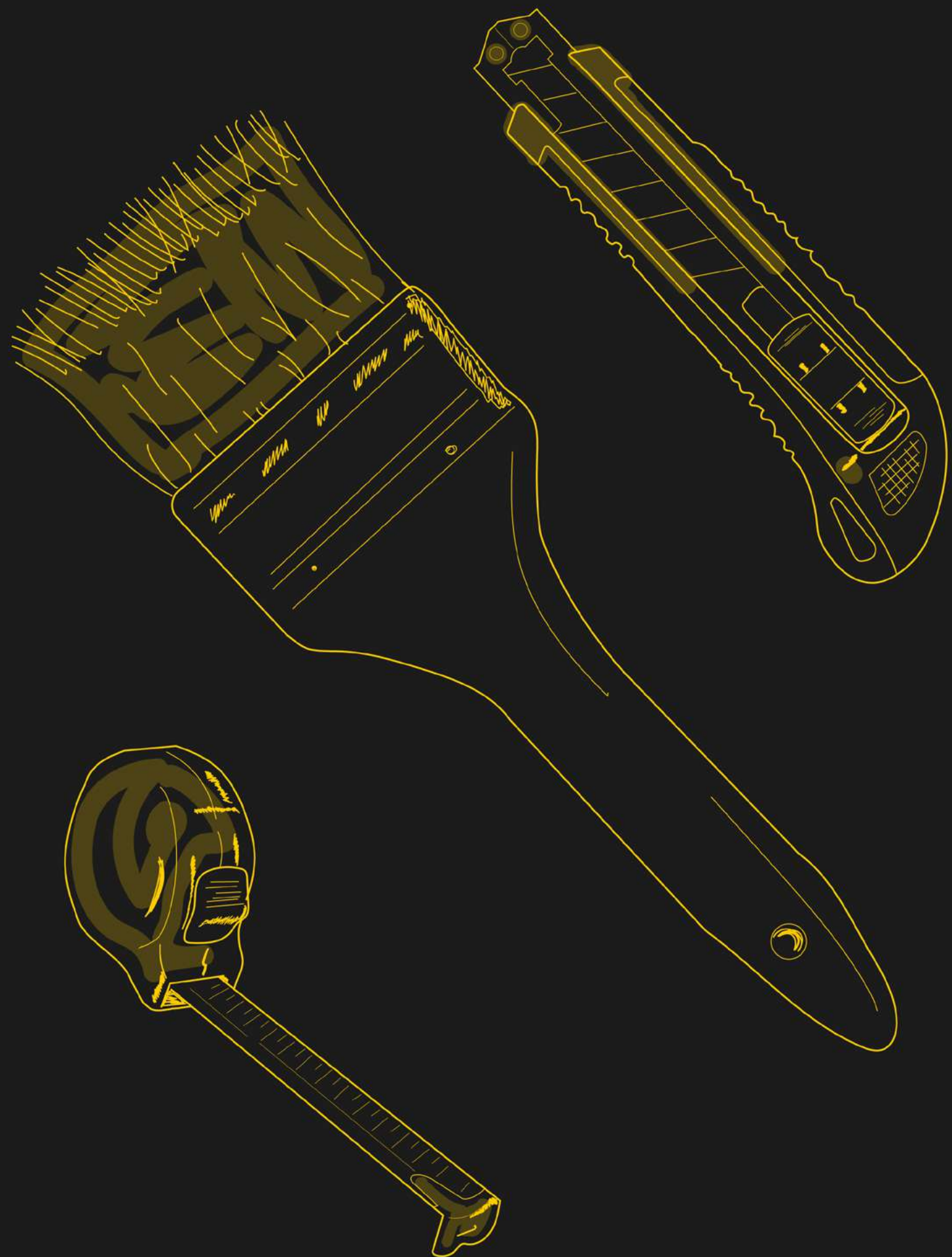

Línea de
HERRAMIENTAS

CALIBRADOR

Bulldog

DORADO REF. IP11617-2

NEGRO REF. IP11617-3



• Utilizado para medir el nivel de presión en llantas.

CALIBRADOR

grande 150 LB

DORADO REF. IP11617-2



• Utilizado para medir el nivel de presión en llantas.

AGUJA

aire x5

REF. 14953



Bomba

aire

REF. 1002-85



CALIBRADOR

redondo mediano

REF. IP11110

CALIBRADOR

aire blister 6"

REF. 1001-73



COSEDORA

R23

REF. 1001-118



LLAVE expansiva

6" REF. 1002-79

8" REF. 1002-80

10" REF. 1002-81



GANCHO

cosedora

REF. 1001-119



LLAVE

Bristol x9

REF. 1002-95



LLAVE

Bristol x10

REF. OW2204-24



LLAVE

Bristol

REF. TF-003

HOMBRE solo

REF. IP1152

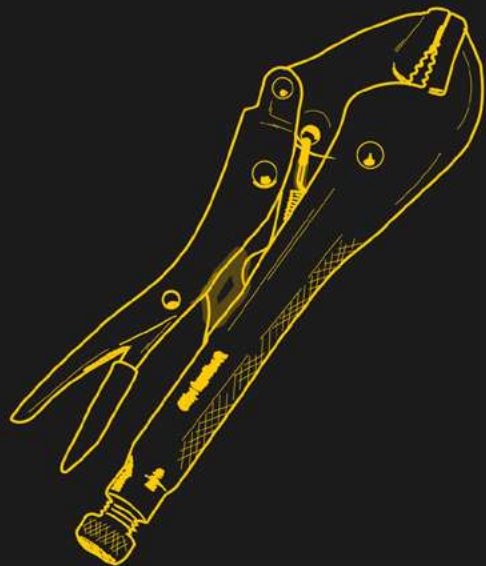

• Utilizado para torcer o quitar objetos duros.



ALICATE económico 8"

REF. IP11191

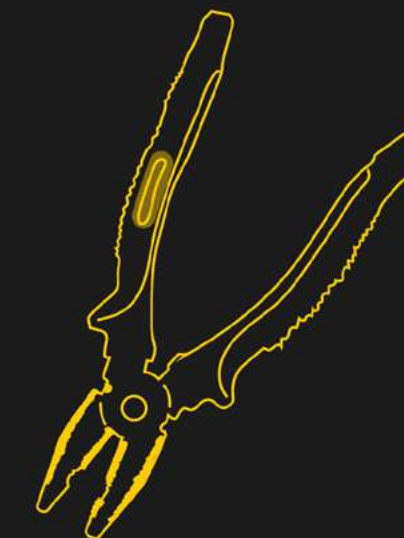

• Utilizado para torcer o quitar objetos duros.

Tenazas



6"

REF. BL0033-3

7"

REF. BL0033-2

• Utilizada para sujetar/quitar objetos difíciles.



CORTAFRÍO 8"

REF. IP11549



• Utilizado para cortar objetos duros.



MARTILLO

Chipote

REF. OW2204-12C



MARTILLO

Enano

REF. OW2204-27



MARTILLO

10"

REF. 1002-103



MARTILLO

Enano

REF. OW2204-28



LLANA

Dentada

REF. 2204-29

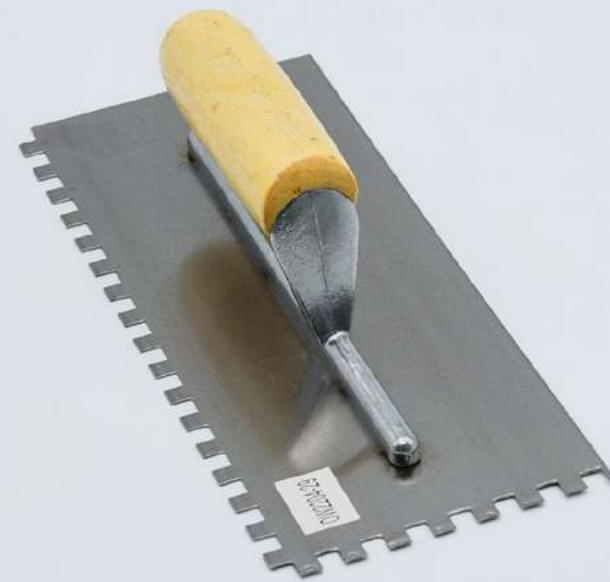

KIT

Jardinería

REF. 1001-149



NIVEL

Torpedo

REF. 1002-101



TAMBO

50cm

REF. 1002-67



ESPÁTULA

brazo

REF. HFQ-401



• Utilizada para limpiar superficies de difícil alcance.



ESPÁTULA

brazo 30cm

REF. IP11187



• Utilizada para limpiar superficies de difícil alcance.

BROCHAS

Grandes

5" REF. 5"

6" REF. 6

4" REF. 4"

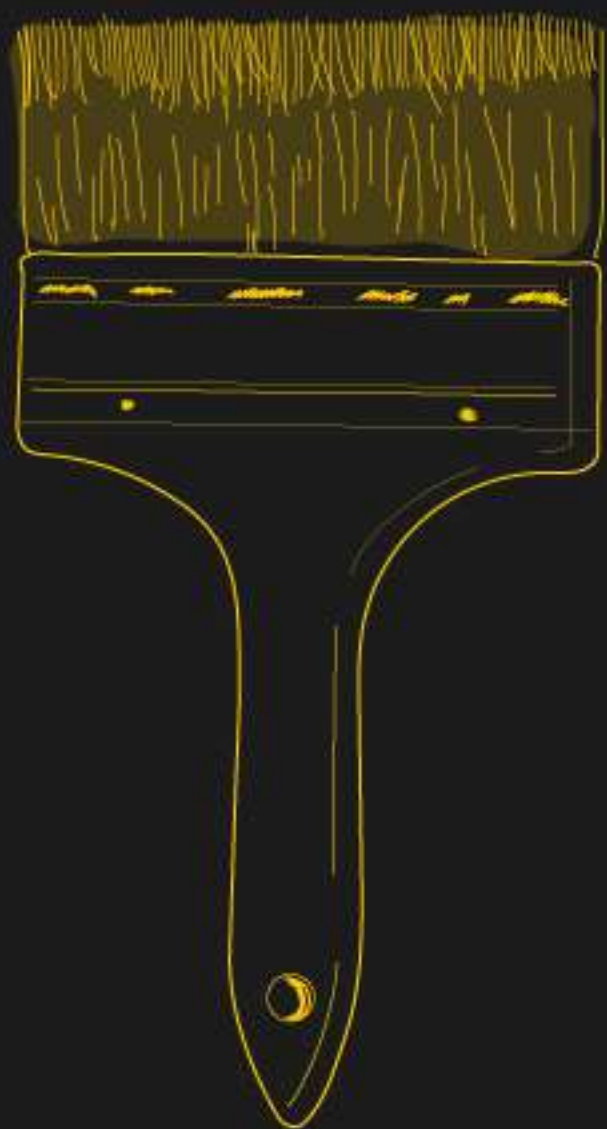

Pequeñas

2" REF. 2"

1.5" REF. 1.5" Agotado

1" REF. 1"



NEGRAS Grandes

6" REF.

4" REF.



PINCEL NEGRO
Plano set X12

REF. OW2204-60



PINCEL NEGRO
Plano set X10

REF. OW2204-64



PINCEL NEGRO
Redondo set X12

REF. OW2204-61



PINCEL NEGRO
Redondo set X6

REF. OW2204-67

PINCEL NEGRO
Plano set X6

REF. OW2204-68

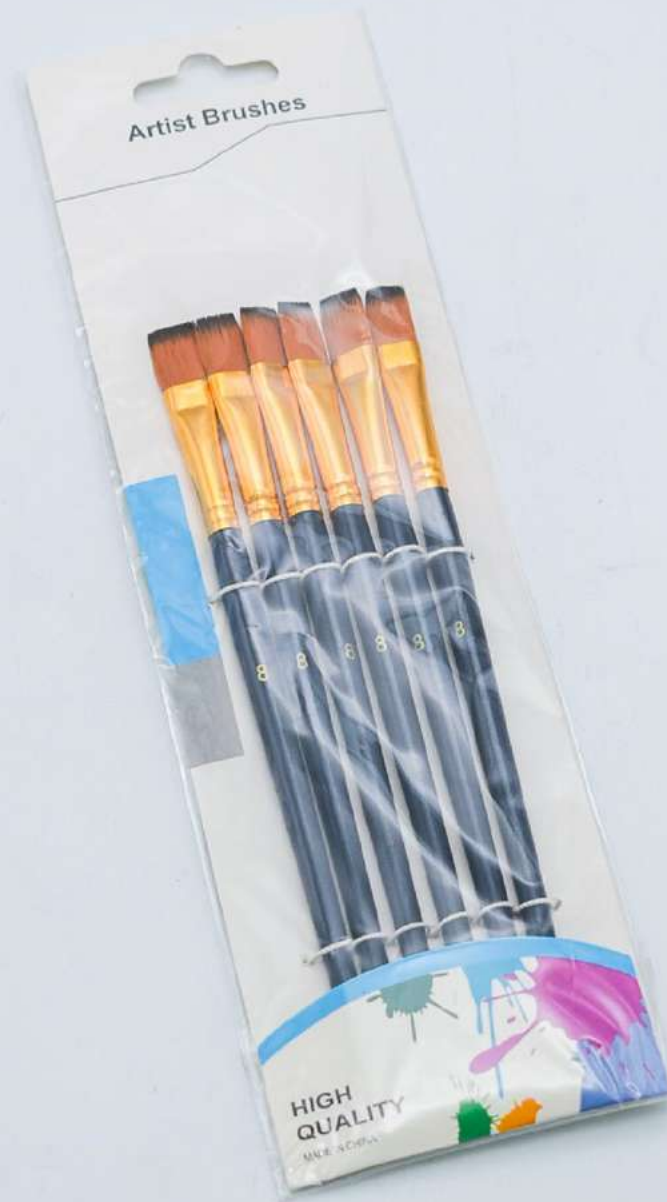

PINCEL ROJO
Plano set X12

REF. OW2204-63



PINCEL ROJO
Plano set X6

REF. OW2204-69

PINCELES

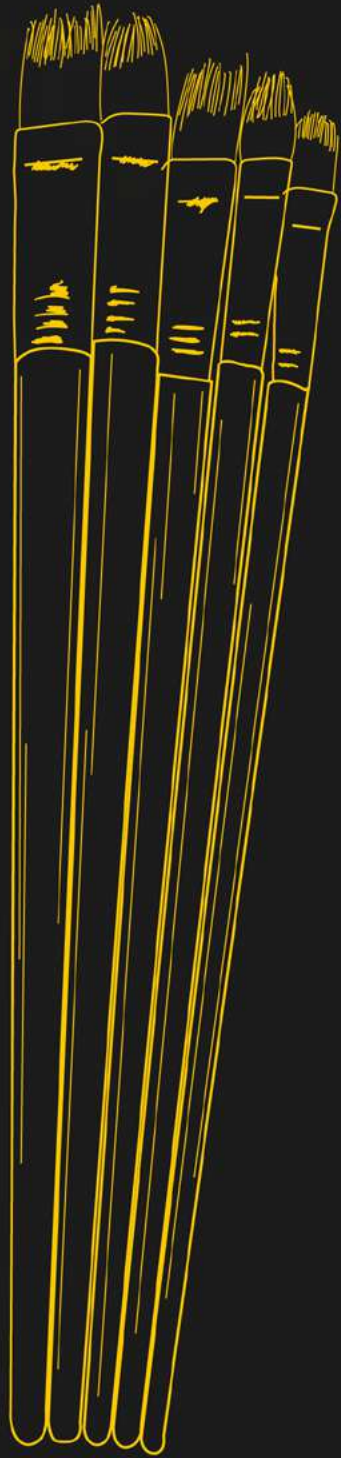

- 1" REF. PIN1
- 2" REF. PIN2
- 3" REF. PIN3
- 4" REF. PIN4
- 5" REF. PIN5
- 6" REF. PIN6
- 7" REF. PIN7
- 8" REF. PIN8
- 9" REF. PIN9
- 10" REF. PIN10
- 11" REF. PIN11
- 12" REF. PIN12



IMÁN

REF. #1



METRO

Amarillo

3MT REF. PCE 36

5MT REF. PCE 59E

8MT REF. PCE 85E

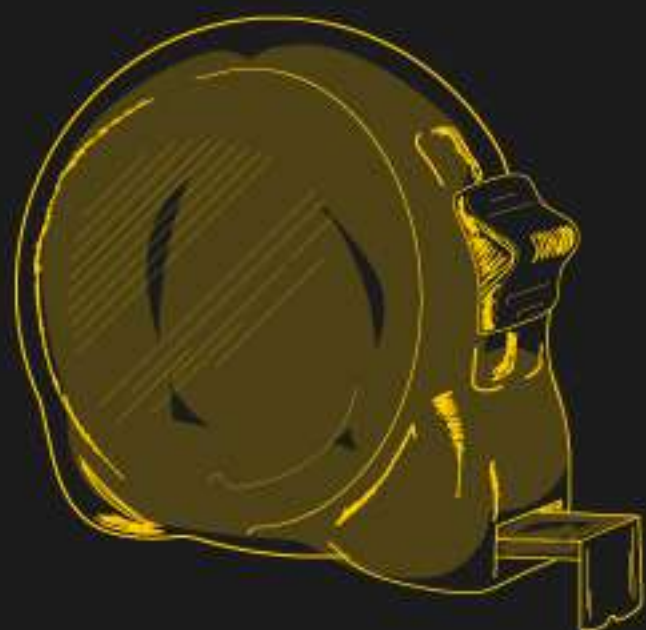

• Utilizado para la medición de objetos.



METRO

Encauchetado

3MT REF. IP11518

5MT REF. IP11519

7.5MT REF. IP11520

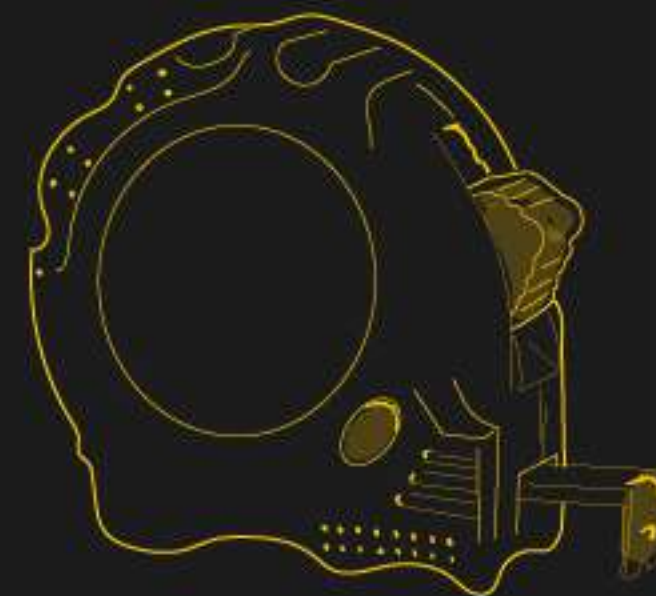

• Utilizado para la medición de objetos.

METRO

Cromado

3MT REF. PCE 36E

5MT REF. PCE 59E

8MT REF. PCE 85E



• Utilizado para la medición de objetos.



METRO

Dorado

3MT REF. 3x16MM GOLD

5MT REF. 5x19MM GOLD

7.5MT REF. 8x25MM GOLD

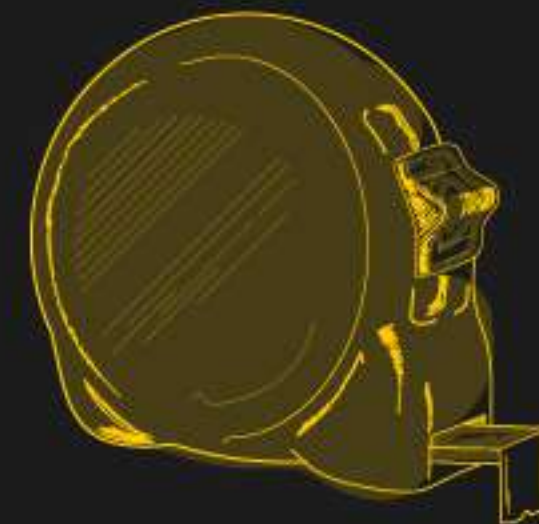

• Utilizado para la medición de objetos.

DECÁMETRO

10M REF. 1002-62

20M REF. 1002-63



METRO

5M encauchetado

REF. 1001-43



METRO

5M uniflex

REF. UFL5M

CANDADO

Seguridad #70

REF. 70MM



CANDADO

Anticizalla LP #80

REF. 80MM



CANDADO

Anticizalla LP #70

REF. OW2204-76



CANDADO

Anticizalla LP #90

REF. 90MM



CANDADO

Anticizalla #70

REF. OW2204-73



CANDADO

Anticizalla #80

REF. OW2204-74



CANDADO

Anticizalla #90

REF. OW2204-75



CANDADO

Seguridad #50

REF. EXTRA-CR50



CANDADO

Seguridad #60

REF. EXTRA-CR60

CANDADO

Aro

3" (76mm)
REF. FE10023

1 1/2" (38mm)
REF. FE10022

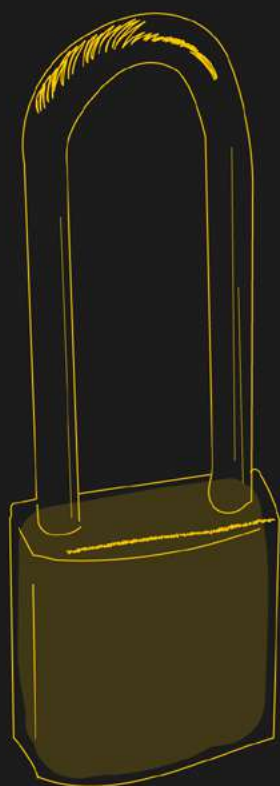

CANDADO

#20 REF. 201



• Utilizado para asegurar pertenencias.

• Utilizado para asegurar cualquier pertenencia.

CANDADO

clave 3L

REF. 1002-50



CANDADO

clave 4L grande

REF. 1002-51



CANDADO

clave guaya

REF. 1001-136



CANDADO encartonado

20 - 25 - 32

REF. 20-25-32MM

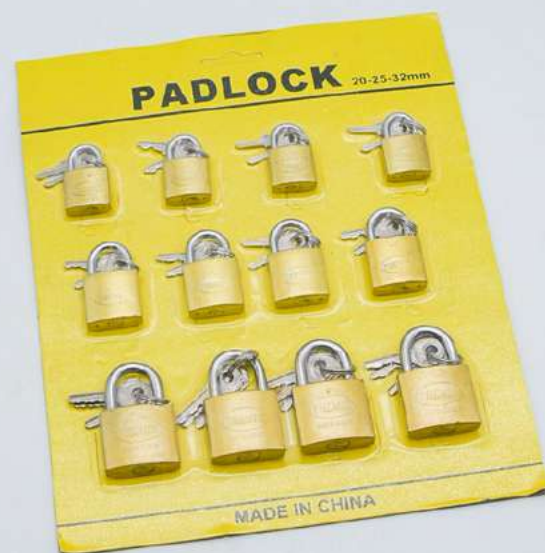

CANDADO encartonado

32 - 38 - 50

REF. 1002-40



CANDADO encartonado

25 - 32 - 38

REF. 1002-39



CANDADO encartonado

38 - 50 - 63

REF. 1002-41



CANDADO
amarillo #63

REF. 1002-47



CANDADO
amarillo #38

REF. 1002-45



CANDADO
amarillo #32

REF. 1002-44

CANDADO

cadena 1M

REF. 1002-49



CANDADO

cadena 60cm

REF. 1002-48



POLEAS

3" REF. 1001-5

2 1/2" REF. 1001-6

2" REF. 1001-7



CHAZOS

Tornillo M10 REF. 1001-56

Tornillo M8 REF. 100157

Tornillo M6 REF. 1001-58

PERROS

#2 REF. 1001-55

#4 REF. 1001-54

#6 REF. 1001-53

#8 REF. 1001-52

#10 REF. 1001-51

#12 REF. 1001-50

#14 REF. 1001-49



CANDADO

LUJO



CHAPA

MANIJA

REF. IP11558

CANDADO

clave guaya

REF. 1001-93



CHAPA

guantera

2 1/2" REF. 1001-67

3" REF. 1001-68

MARCO SEGUETA
mango naranga

REF. AL833

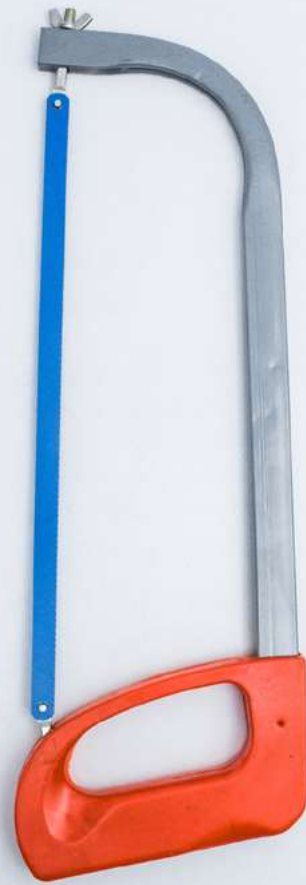

MARCO
Segueta

REF. 1002-113

CALADORA
manual

REF. H0637



SERRUCHO
de poder

REF. 1001-8

BISTURÍ

REF. IP11368



BISTURÍ con repuesto

REF. 1002-91



BISTURÍ metálico

REF. ZY-866



CUCHILLA Bisturí

REF. 1001-4



BISTURÍ

tira x12 Grande

REF. 1002-92



BISTURÍ

tira x12 Pequeña

REF. 1002-93

CINTAS

ANTIDESLIZANTE

Blanca

REF. 50X5 TRANS

x5m



ANTIDESLIZANTE

Neón

REF. CINTA NEÓN

x5m



CON PLÁSTICO

110X20

x20m



DRYWALL

REF. 1001-182

GRIS 2"

REF. 1001-17

Doble Faz 2M

REF. 1001-25

• Utilizada para protegerse de deslizamientos y mantener una guía.

REFLECTIVA ROJA

10mt REF. 1001-151
45mt REF. 1001-156
Agotado



REFLECTIVA AMARILLA

10mt REF. 1001-154
45mt REF. 1001-159
Agotado



REFLECTIVA VERDE

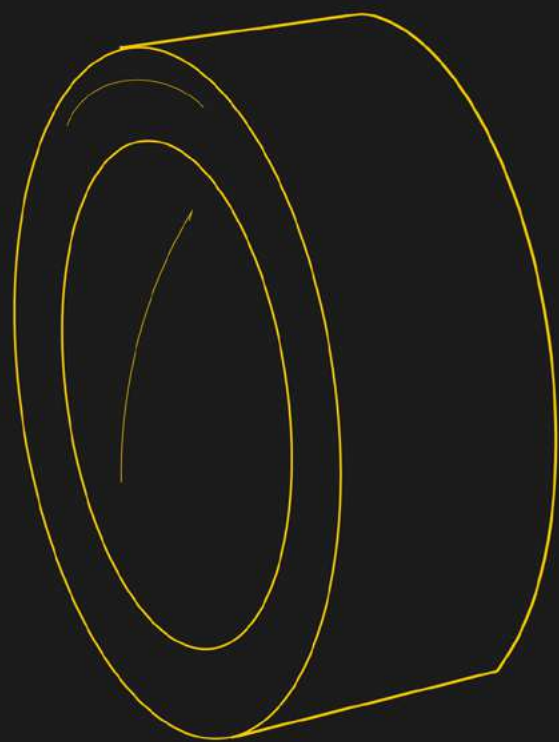

10mt REF. 1001-153

45mt REF. 1001-158
Agotado



REFLECTIVA BLANCA



10mt REF. 1001-155

45mt REF. 1001-160
Agotado

**REFLECTIVA
TELA VERDE**

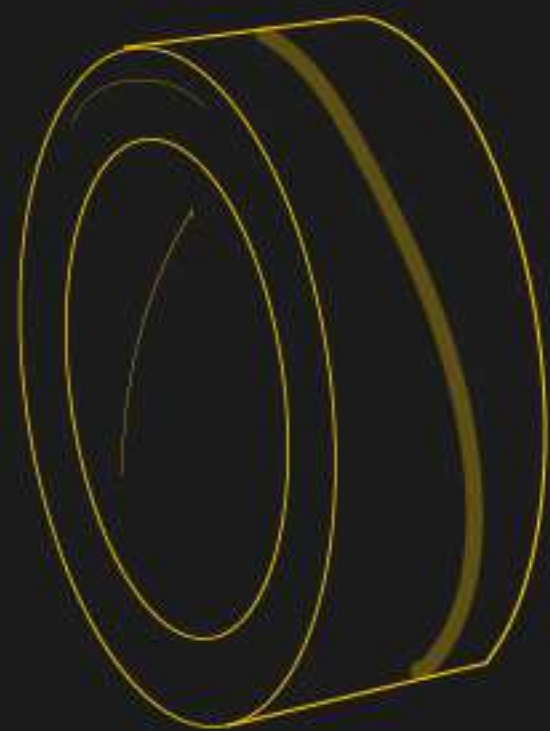

200mt REF. 1001-161



**ANTIDESLIZANTE
NEGRO-AMARILLO**

1" REF. 1001-19

2" REF. 1001-21



**ANTIDESLIZANTE
NEGRO**

1" REF. 1001-20

2" REF. 1001-22

CORTAFRÍO

8"

REF. 1001-1



ALICATE

8"

REF. 1001-2



PINZA

puntalarga 8"

REF. 1001-3



PELACABLE

REF. 1002-72



HOMBRE SOLO

#10

REF. 1002-118



PELACABLE

REF. OW2204-11



TENAZA

8"

REF. 1002-60



DESTORNILLADOR
10" magnético

REF. IP11292



DESTORNILLADOR
Tatamaco doble

REF. 1002-99



DESTORNILLADOR
Tatamaco

REF. OW2204-46



DESTORNILLADOR
Magnético x6

REF. 1002-98



TESTER
Azul-amarillo doble

REF. IP997

TESTER

15 cm

REF. 1001-128



DESTORNILLADOR

Relojero

REF. 1001-36

TESTER

18 cm

REF. 1001-129



CORTA VIDRIO

REF. 1001-35

LIMAS

TRIANGULAR

REF. O2208-1A

PLANA

REF. O2208-1B

RABORUNCHO

REF. O2208-1C



LIMA

8" SET x5

REF. OW2204-35



LIMA

SET x5

REF. OW2204-36

ABRELATAS metálico

REF. 1002-74



ABRELATAS limpiador

REF. 1002-66



NAVAJA madera x12

Grande REF. 1002-71

Pequeña REF. 1002-68



NAVAJA negra x12

REF. 1002-70



NAVAJA esqueleto

REF. 1002-69



PISTOLA

Silicona Pq

REF. 1001-176



PISTOLA

Silicona Gr

REF. 1001-177



ZIMBRA

REF. 1002-94



CAUTÍN

60W

REF. OW/2204-33



ESTAÑO

carrete 1.5 30Gr

REF. 1001-16

CORREDERA

cierre lento

30cm REF. 1001-94

35cm REF. 1001-95

40cm REF. 1001-96

50cm REF. 1001-97



RODACHINES

Plataforma 3" REF. 1001-103

3" REF. 1001-104

4" REF. 1001-105

5" REF. 1001-108

CON FRENO

4" REF. 1001-106

5" REF. 1001-107

CAUCHOS PARA MOTO

**Caucho
moto 2 mt**

REF. 1002-77



**Caucho moto
1.5 mt**

REF. 1001-137



**Caucho moto
40X40**

REF. 1001-138

TIJERA modistería

REF. 24578



TIJERA pequeña x24

REF. 1001-135



HILO Cartufo

REF. 1001-168



GANCHO Nodriza Cromo

REF. 1001-172



METRO modistería

REF. 1001-167



GANCHO Nodriza oro

REF. 1001-173



PARCHE

X12

REF. 1001-114



PARCHE

PQ x36

REF. 1001-116



PARCHE

PQ x24

REF. 1001-115



PARCHE

GR x24

REF. 1001-117



REGISTRO

de gas PN-40

REF. IP11608



• Utilizada para para permitir el paso de gas.

PALUSTRE

6" REF. 1001-45

7" REF. 1001-46

8" REF. 1001-47

9" REF. 1001-48



ESPONJILLA

X12

REF. J812B

TIJERA

de podar

REF. 1001-146



AGUJAS

REF. IP10175-1



CÁNCAMOS

Cerrado



#4 REF. BL55560B-4
#5 REF. BL55560B-5
#12 REF. IP11317-2

#16 REF. IP11317-4
#18 REF. IP11317-5
#20 REF. IP11317-6

Abierto

1/2" REF. 37152
1" REF. 37156
5/8" REF. 37153
7/8" REF. 37155



• Utilizado como objeto para sostener.

COPAS

cromadas

REF. BL-A0154



1/2" X 16
1/2" X 21
10mm
11mm
13mm

• Utilizados para ajustar/desajustar tuercas.

CAUCHO

150G

REF. 1001-165



CAUCHO

30G

REF. 1001-164



CAUCHO

en paquete GD

REF. O2208-9



DILATADORES

2 REF. 1001-74

2.5 REF. 1001-75

3 REF. 1001-76



CLIP

para cable

4mm REF. 1001-77

5mm REF. 1001-78

6mm REF. 1001-79

7mm REF. 1001-80

PUNTERO

pala

REF. OW/2204-15



PUNTAS

MOTORTOOL x10

REF. ZP-1005



PUNTAS

MOTORTOOL x5

REF. ZP-1006

TRICETAS

#8, #9, #10

REF. OW2204-41A

#8, #10, #12

REF. OW2204-41B

#10, #12, #14

REF. OW2204-41C

#12, #14, #17

REF. OW2204-41D

#14, #17, #19

REF. OW2204-41E



PUNTAS DRYWALL

REF. BT001



ACOUPLE Compresor x5

REF. O2209-2

TIMBRE
Inhalambrico

REF. 8306



TIMBRE
Inhalambrico

REF. 006



TIMBRE
Inhalambrico

REF. 8206



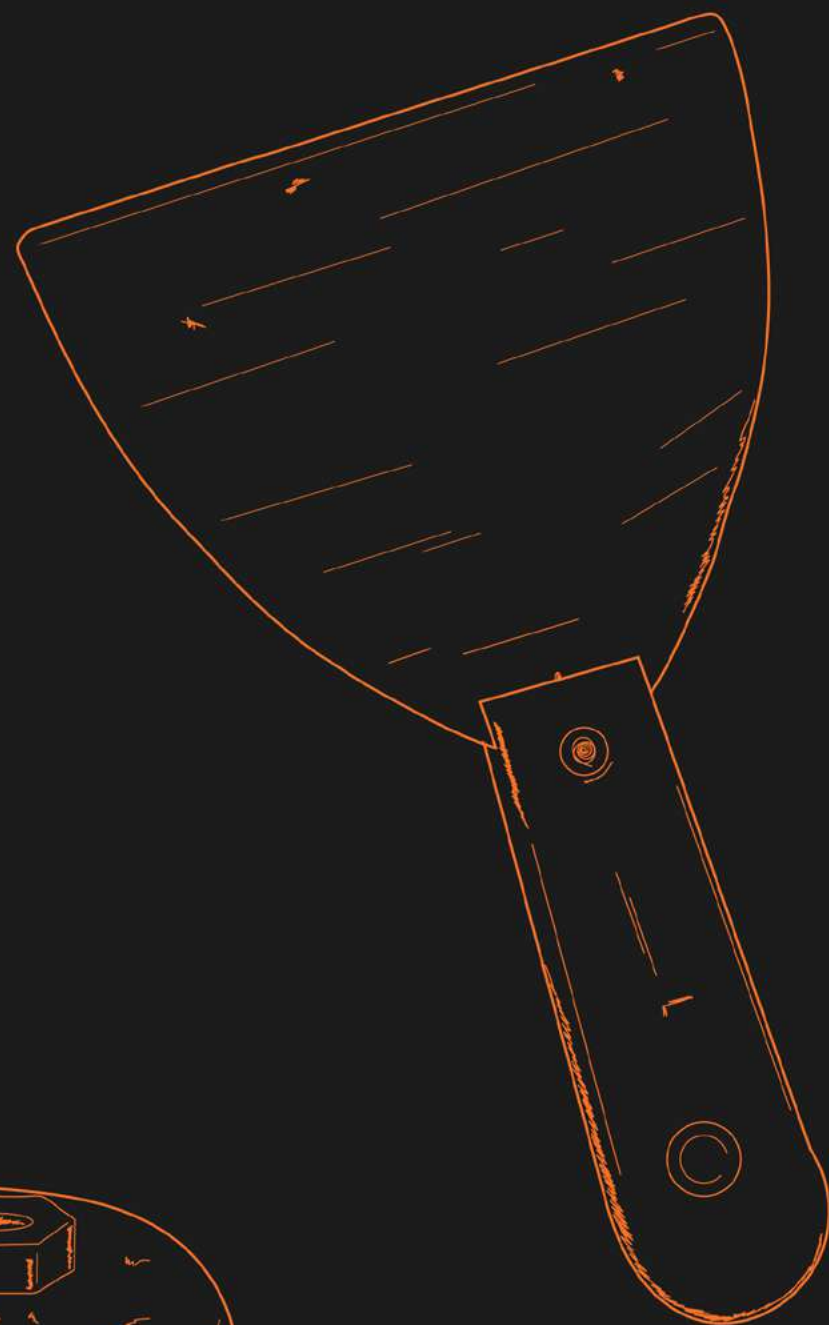

Línea de **ABRASIVOS**

DISCO

tronzadora 14"
REF. 1001-13

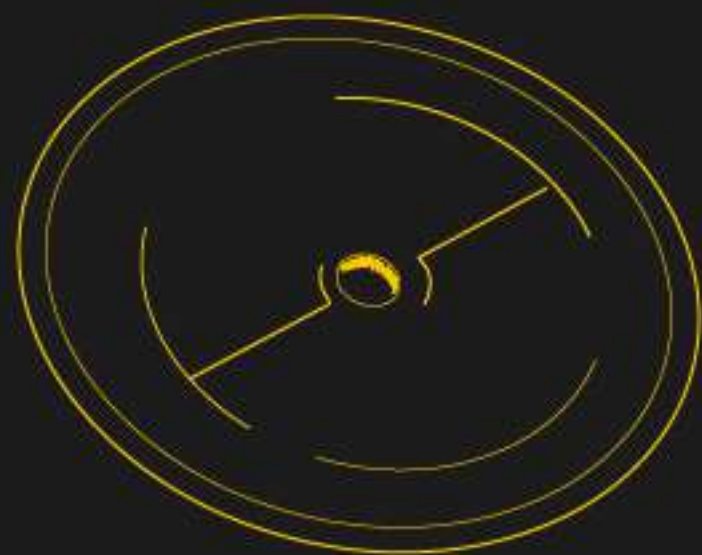

DISCO

CD 7"
REF. 1001-15

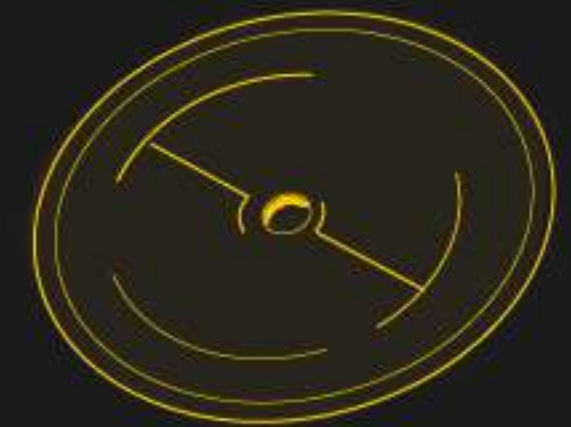

DISCO

flap

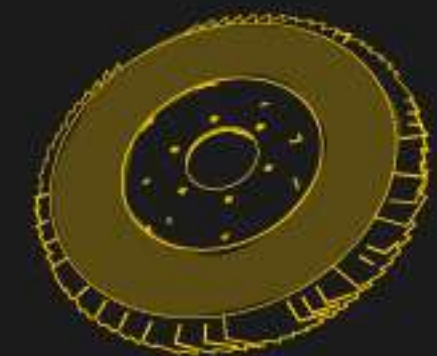

G60 #7 REF. 1002-56

G80 #7 REF. 1002-57

G100 #7 REF. 1002-58

G120 #7 REF. 1002-59

DISCO FLAP

REF. IP13004

4 1/2 #100

4 1/2 #120

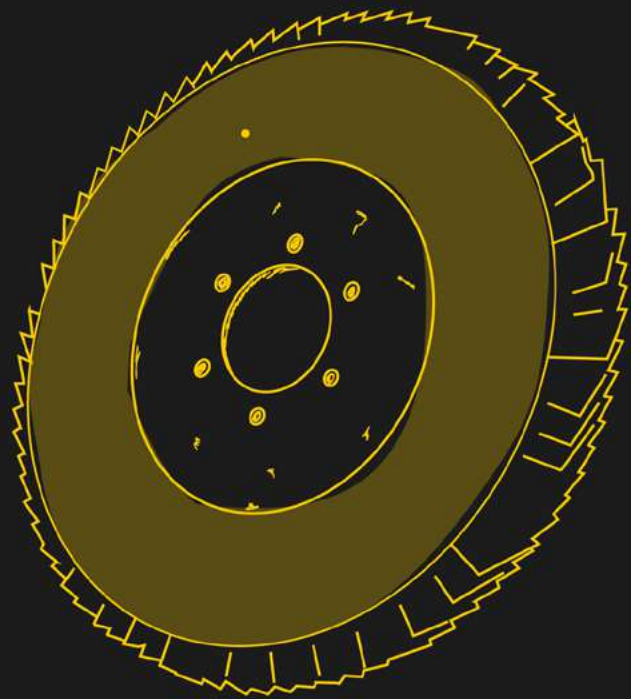

DISCO #7

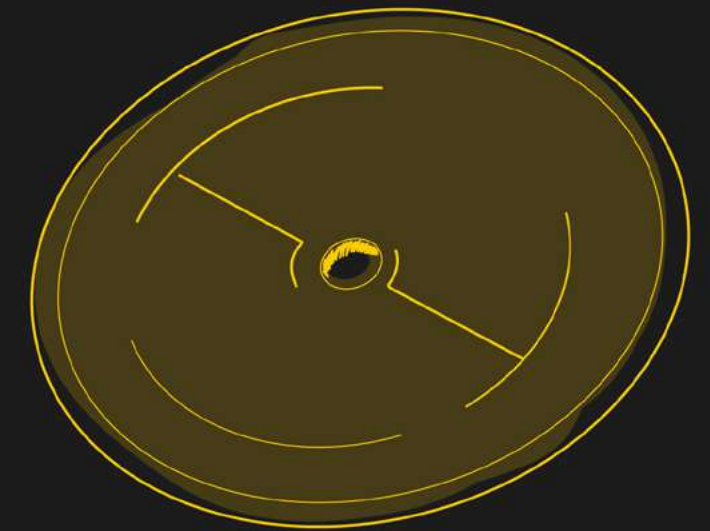

• Utilizado para un cepillado agresivo en superficies fuertes.

GRATA

Set x6

REF. OW2204-18



GRATA

pelo 1 1/2"

REF. 1002-53



GRATA

copa pelo 2"

REF. 1002-55

GRATA

Set x5

REF. OW2204-17



GRATA

pelo 2"

REF. 1002-54

GRATA

disco Bulldog 4 1/2

REF. 25410

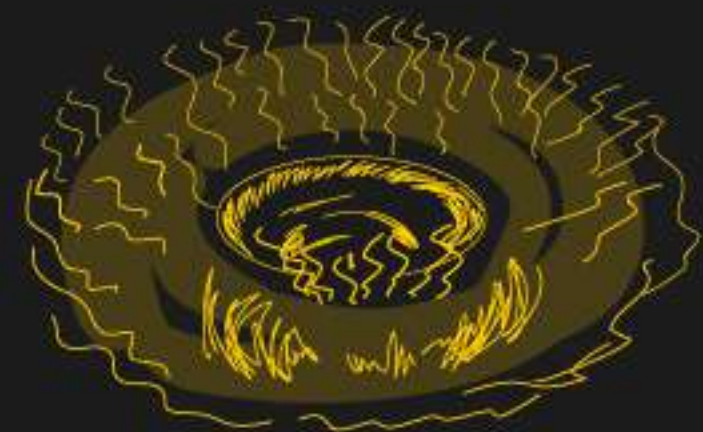

• Utilizado para un cepillado agresivo en superficies fuertes.



GRATA

cepillo 9" x3

REF. 1002-97



GRATA

cepillo 7" x3

REF. 1002-96

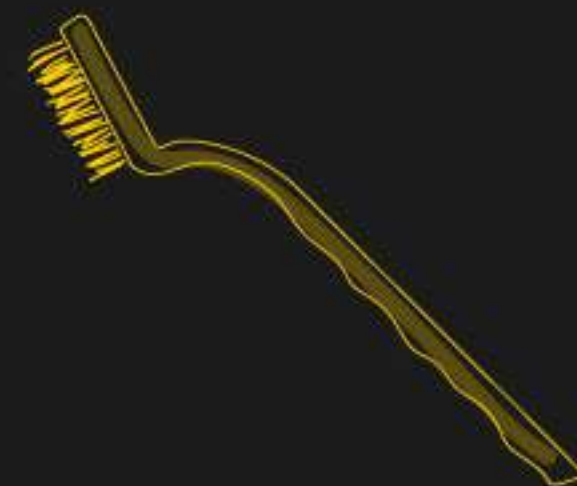

DISCO

sierra 4" x40D

REF. 1001-120

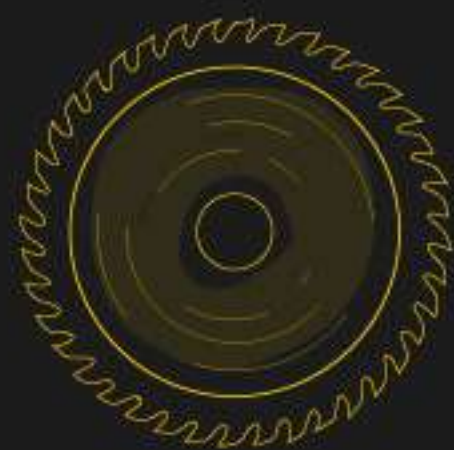

DISCO

sierra 9" x40D

REF. 1001-122

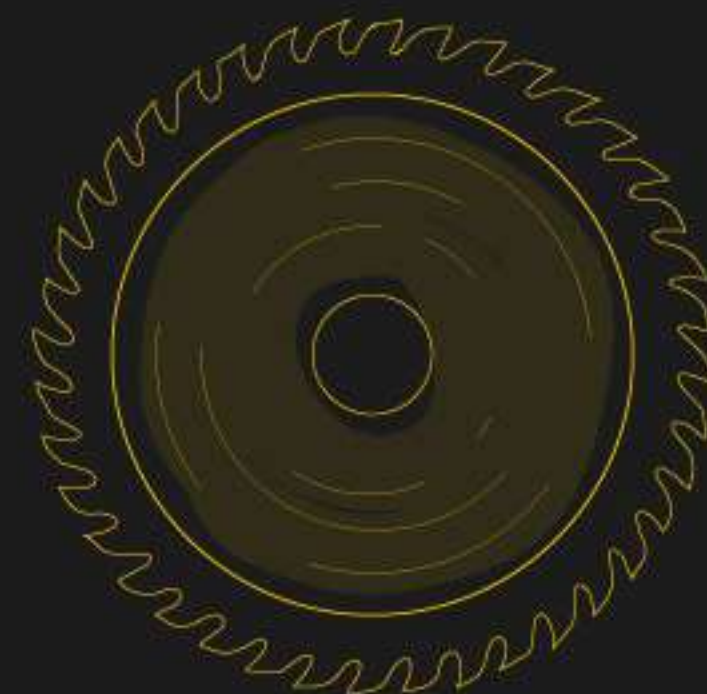

DISCO

segmentado 4"

REF. 1001-123

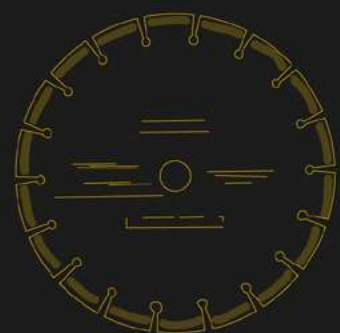

DISCO

segmentado 7"

REF. 1001-124

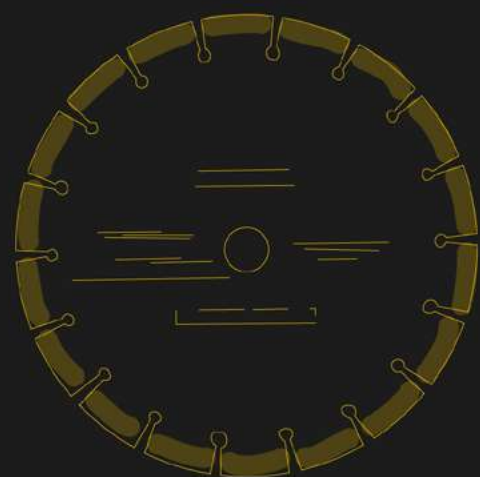

DISCO

segmentado 9"

REF. 1001-125



• Utilizados para corte de superficies gruesas y profundas.

DISCO

doble copa seg.
4.5

REF. IP11596



DISCO

copa 4"

REF. 1001-126



ESPÁTULA

5"

REF. IP11062-5



• Utilizado para limpiar superficies.

MANDRIL

taladro 1/2

REF. 1/2-20UNF

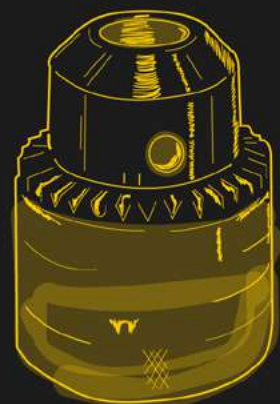

• Utilizado para conectar el taladro y la broca.



LLAVE

taladro

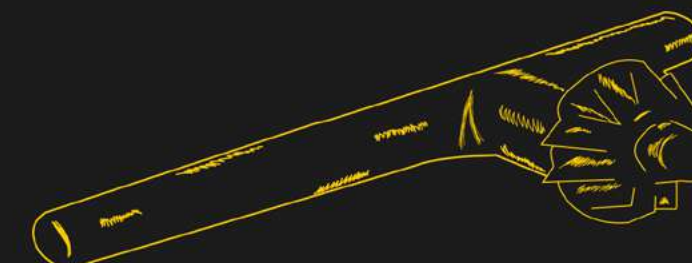

3/8 REF. IP0915

1/2 REF. IP0914

1/2 REF. 1001-64

• Utilizado para ajustar / desajustar las brocas del taladro

MANDRIL

taladro 3/8

REF. IP110A-2P



• Utilizado para conectar el taladro y la broca.



PUNTAS

taladro x20

REF. 1001-44

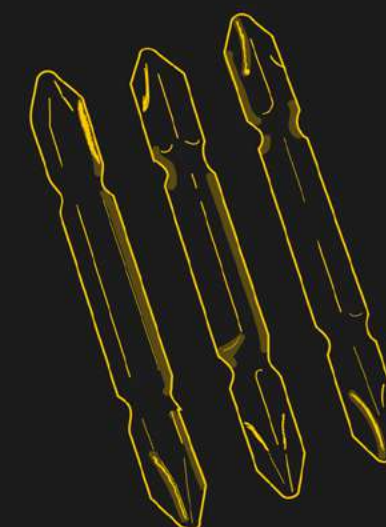

CUCHILLA

caladora madera

REF. 1001-62

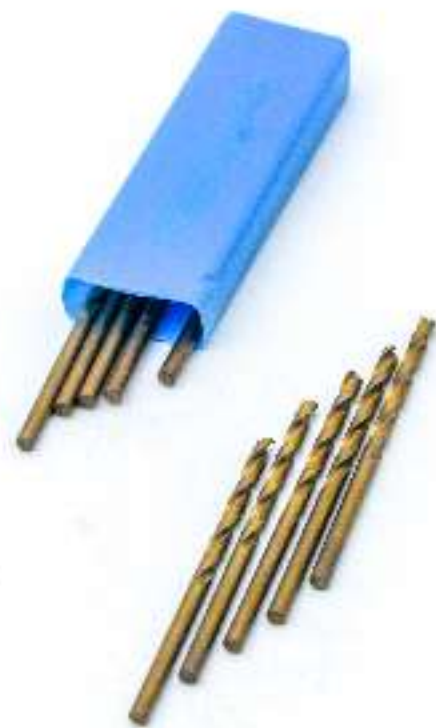
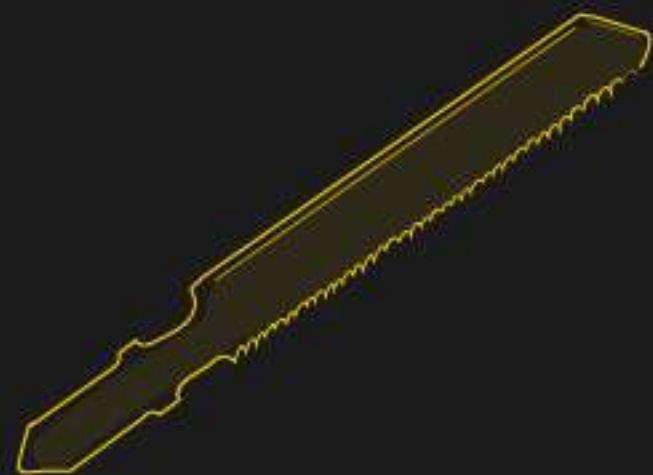

BROCAS

FPB

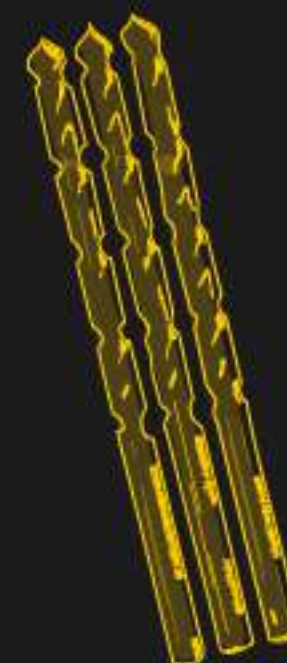

Madera x9

REF. 1001-127

CUCHILLA

caladora metal

REF. 1001-63

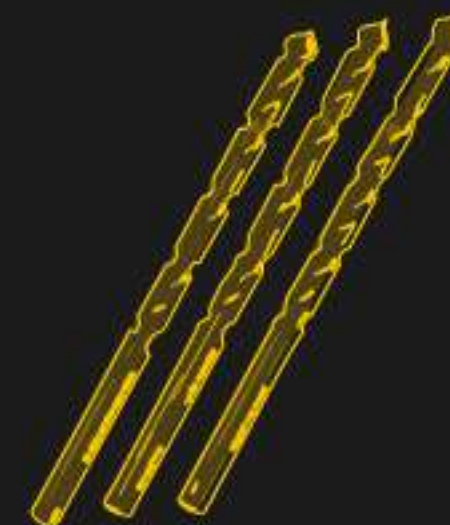
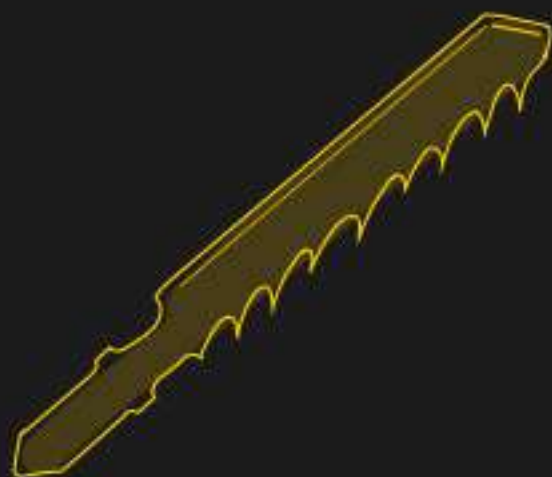

• Utilizadas para perforar superficies duras.

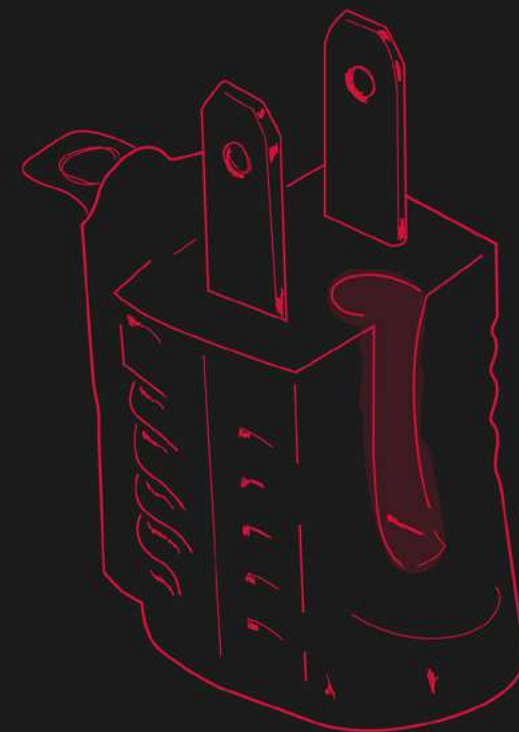
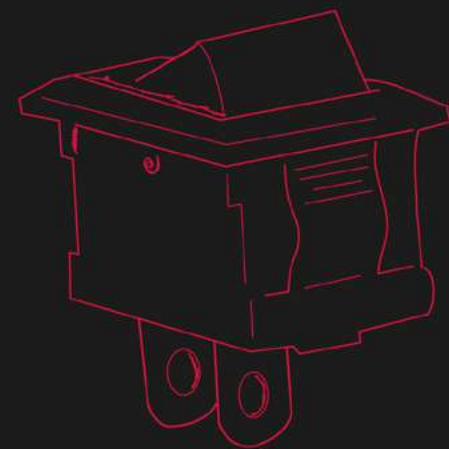
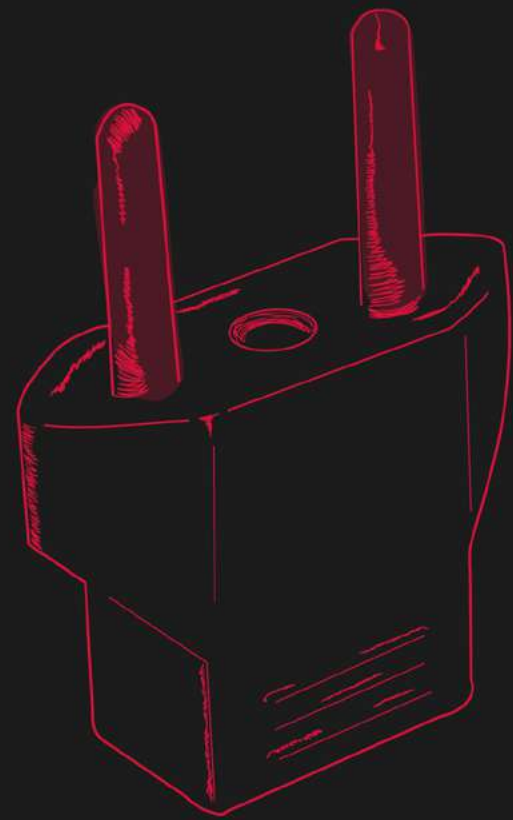

Línea **ELÉCTRICA**

EXTENSION

Blanca



9 FT REF. VT-9

15 FT REF. VT-15



CINTA LED

5M

REF. 1001-92

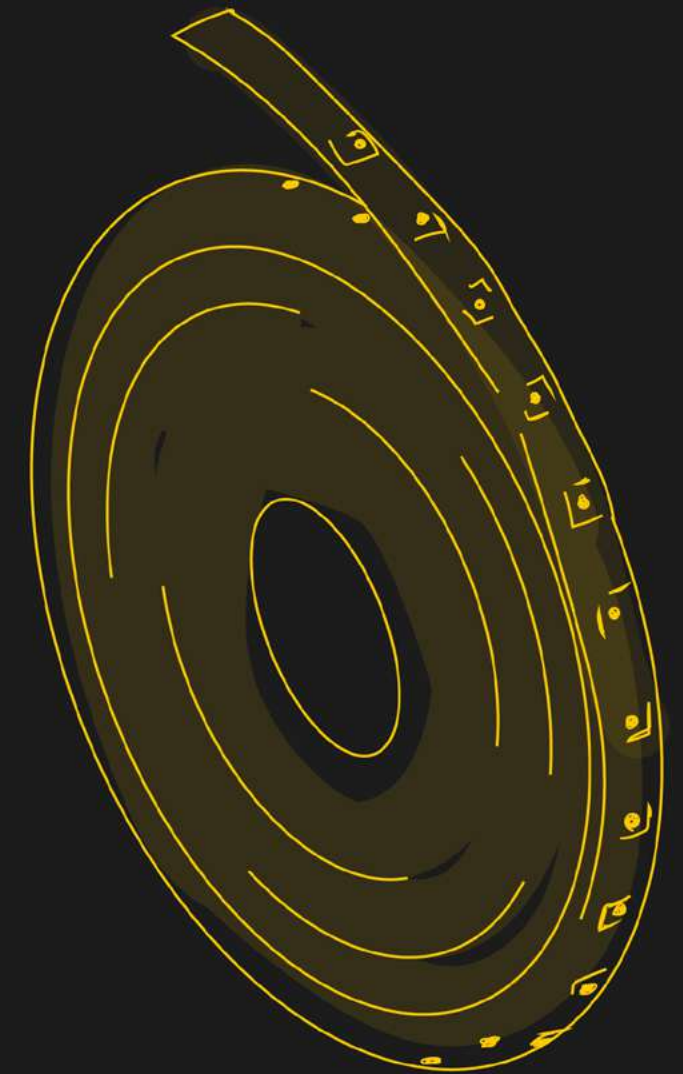

CABLES AUDIO

Audio Video 3x3

REF. 1001-134



Audio Video 1x2

REF. 1001-133



Cable grabadora

REF. 1001-132



CABLES HDMI

3 metros

REF. 1001-92



ANTENAS CONEJO

REF. 1001-109



ANTENAS BASE

REF. 1001-110



CABLE
Iniciar 1000amp

REF. OW2204-38C



CABLE
Iniciar 800amp

REF. OW2204-38B



CABLE
Iniciar 500amp

REF. OW2204-38A



PULSADOR

REF. OW/2204-140



BENJAMIN Enchufe

REF. 1001-130



TERMINALES

REF. 28B

REF. 48B

REF. 5.2

REF. 63A

REF. 63B

REF. 42A

• Utilizado como punto de conexión eléctrica.

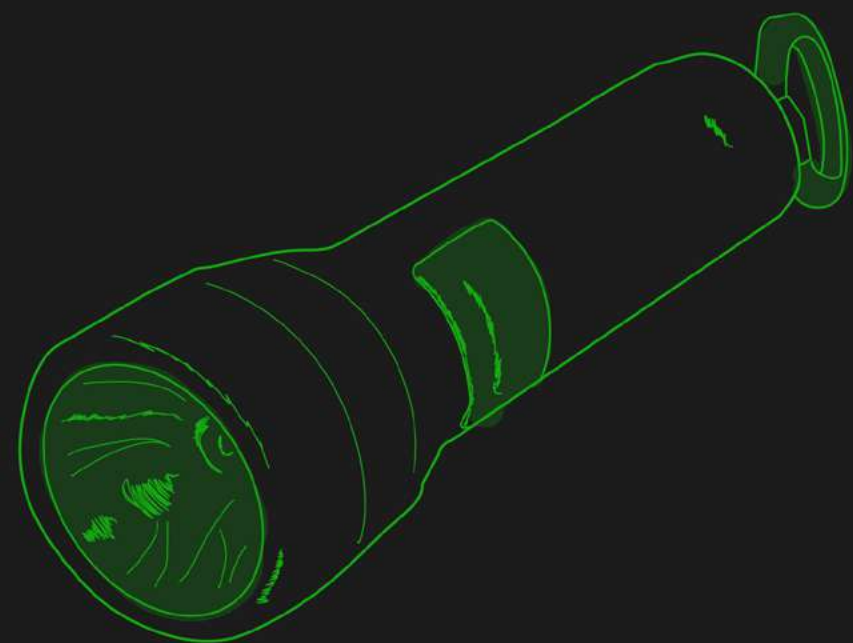
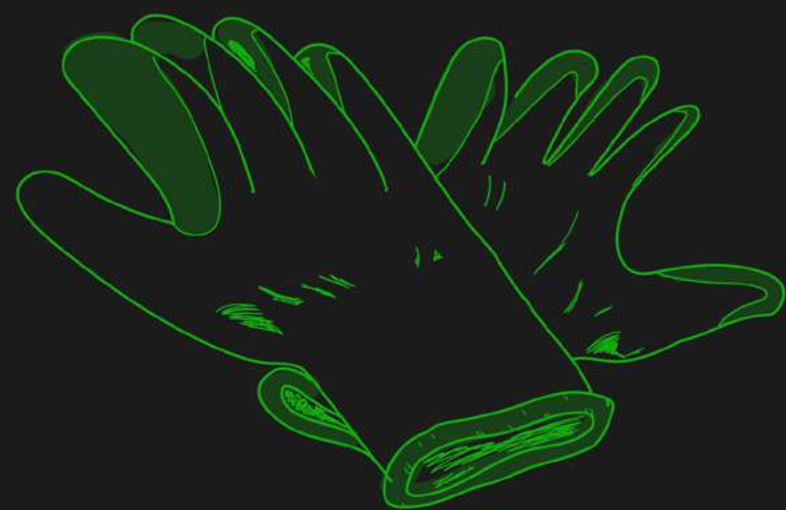

Línea
INDUSTRIAL

CARETAS

fotosensibles

REF. 2307-12



REF. 1002-17

REF. 2307-13



REF. 1002-19



REF. 2307-15



REF. 2307-16



REF. 1002-24



REF. 1002-26



REF. 2307-17



REF. 1002-30



MONOGAFA

moto

REF. 1002-8



CARETA

acrílica

REF. 1002-13

MONOGAFA

TOMMY

REF. 1002-4



CARETA

de agarre

REF. 2204-88

MONOGAFA

soldar

REF. BL0047



RESPUESTO

fotocelda

REF. 1002-14

GUANTE

TALLA S REF. 1002-104

TALLA M REF. 1002-105

TALLA L REF. 1002-106



GUANTE

nitrilo

REF. 1002-10



GUANTE

REF. F-2020

GUANTE

nitriilo 7" rojo

REF. F-1977

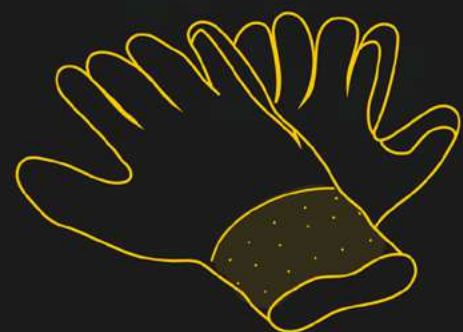

GUANTE

nitriilo 9" azul

REF. F-1979

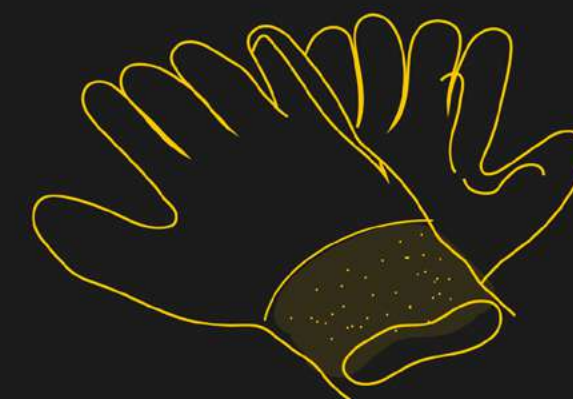

GUANTE

nitriilo 8" amarillo

REF. F-1978

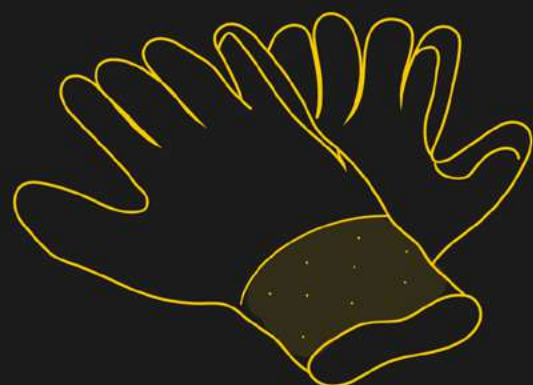

GUANTE

nitriilo 10" blanco

REF. F-1000

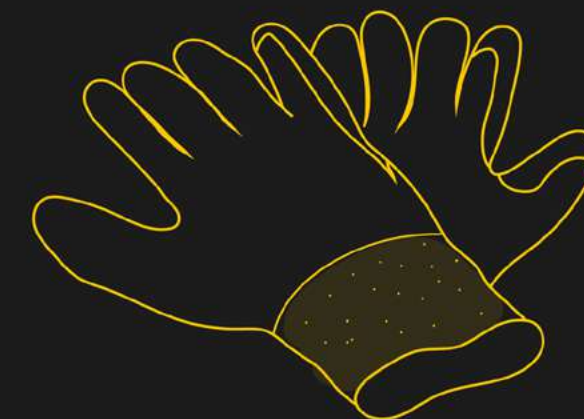

LINTERNA

MINERA 5LM

REF. BD2.5LM



• Adaptable a casco minero.

LINTERNA

MINERA 3.5LM

REF. BD3.5LM



• Adaptable a casco minero.

LINTERNA

MINERA 2.5LM

REF. BD2.5LM-CREE



LINTERNA

MINERA 2.5LM

REF. BD2.5LM

• *Adaptable a casco minero.*

• *Adaptable a casco minero.*

STOP

bicicleta

REF. 368-1v



• Da visibilidad a los ciclistas en la vía.



LINTERNA SOLAR

30 LED

REF. 30LED

• Panel solar para recarga incluido.

ARO LED

luz bicicleta

REF. 13931



• Dar visibilidad a los ciclistas en la vía.



LINTERNA IMÁN

REF. BL0056

• Iluminación en lugares de difícil acceso.

LINTERNA
Tigre 1 LED

REF. 1001-163



LINTERNA

Verde pequeña

REF. 1001-84

LINTERNA

LED recargable x3

REF. SY-8001C



LINTERNA

LED x3
REF. 1001-88



LINTERNA

Casco con USB
REF. SQ-851



LINTERNA

LED x2
REF. KK-C50



LINTERNA

Casco AA
REF. 1001-91



LINTERNA

Negra recargable
REF. 1101



LINTERNA

USB x2
REF. HY-025



TAPA OÍDO

en bolsa

REF. OW04-1B



TAPA OÍDO

cordón

REF. 1002-114



TAPA OÍDO

en caja

REF. OW04-1C



TAPA OÍDO

goma

REF. N-4201



CARRERA 22
18-21

Línea
BULLDOG

BULLDOG BÁSICA



FLUORESCENTE



METÁLICO



ALTAS TEMPERATURAS



RUBBER



SILICONA 450mL



SILICONA 354mL



JAGUAR



MEDIUM



ESPECIAL



VERSUS



BOQUILLAS

- Skinny
- Lego
- NY Fat
- Astro Fat
- Transversal
- Needle
- Adaptador macho/hembra



MARCADOR

15mm

- Negro
- Blanco
- Rojo
- Magenta
- Azul
- Amarillo



MARCADOR

7mm

- Negro
- Blanco
- Rojo
- Magenta
- Azul
- Amarillo